



**ORRELL**  
masonry supply, inc.



This is an original unpublished drawing created by Morrell Masonry Supply, Inc. It is submitted for your personal use in connection with a project being planned for you by Morrell Masonry Supply, Inc. It is not to be shown to anyone outside your organization, nor is it to be used, reproduced, copied, or exhibited in any fashion.  
ALL RIGHTS RESERVED!

501 W. Parker Road. Houston, Texas 77091

Phone : (713) 691-6565 Fax : (713) 691-6564

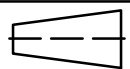

MM#:

REV:  
A



**ORRELL**  
masonry supply, inc.

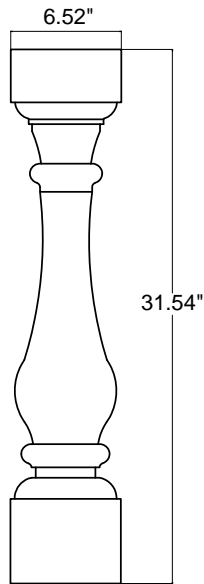

MBL#407

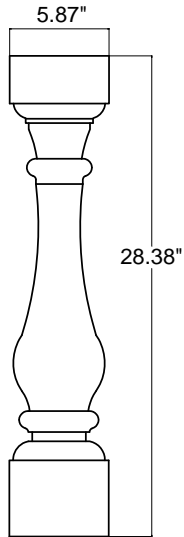

MBL#408

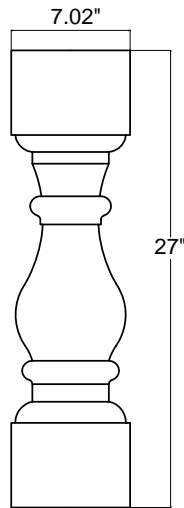

MBL#409



MBL#410

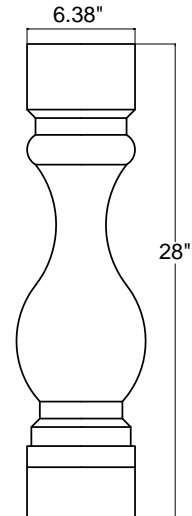

MBL#411

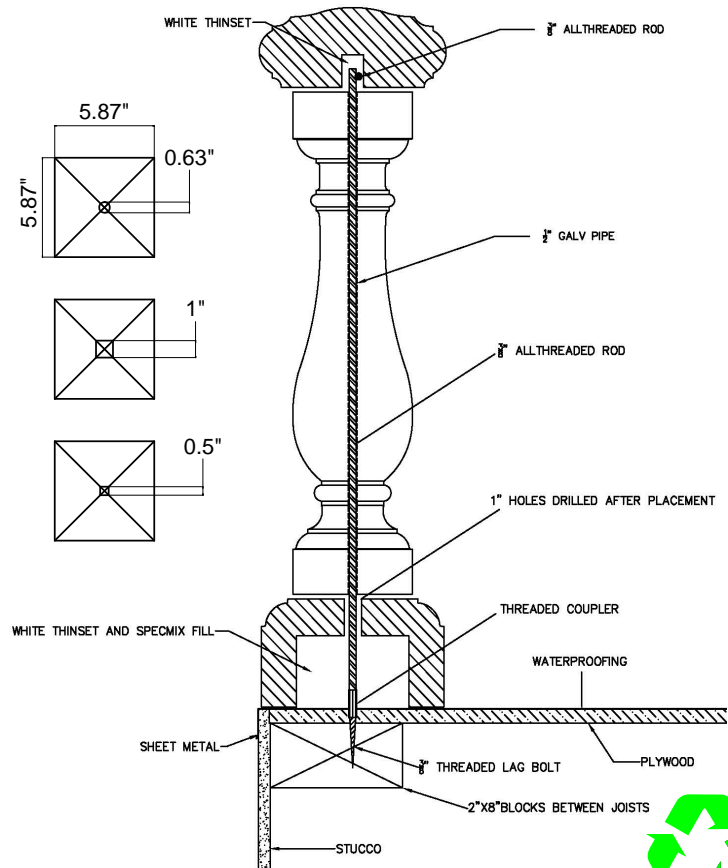

This is an original unpublished drawing created by Morrell Masonry Supply, Inc. It is submitted for your personal use in connection with a project being planned for you by Morrell Masonry Supply, Inc. It is not to be shown to anyone outside your organization, nor is it to be used, reproduced, copied, or exhibited in any fashion.

ALL RIGHTS RESERVED!

Material: EPS 1.0#	501 W. Parker Rd. Houston, Texas 77091
Material: EPS 2.0#	Phone : (713) 691-6565
	Fax : (713) 691-6564

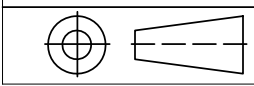

<b>Balustrades</b>	MM#:	REV: <b>A</b>
--------------------	------	---------------

## Flatstocks

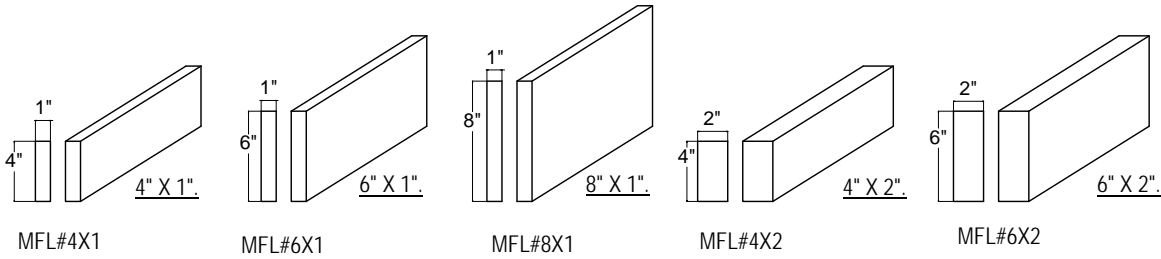

## Flatstocks with Slope

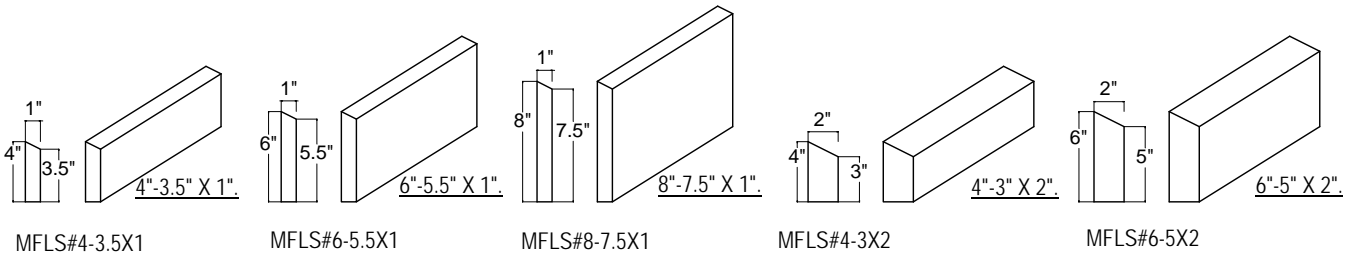

## Bands

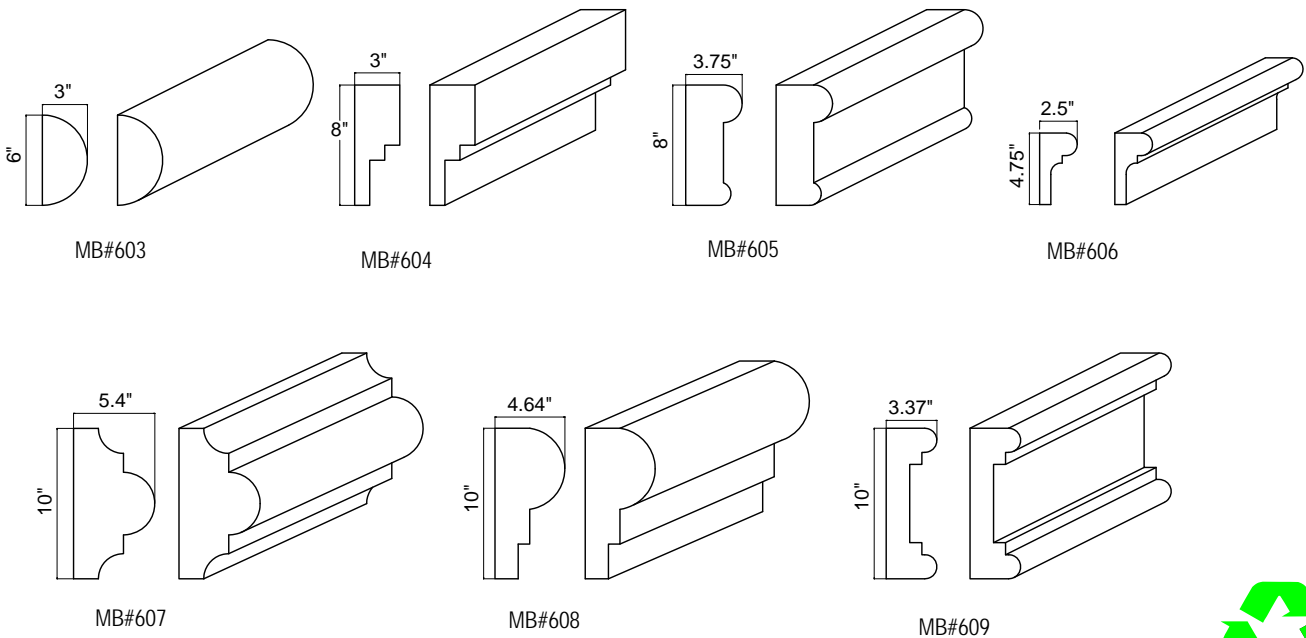

This is an original unpublished drawing created by Morrell Masonry Supply, Inc. It is submitted for your personal use in connection with a project being planned for you by Morrell Masonry Supply, Inc. It is not to be shown to anyone outside your organization, nor is it to be used, reproduced, copied, or exhibited in any fashion. ALL RIGHTS RESERVED!

501 W. Parker Rd. Houston, Texas 77091	
Material: EPS 1.0#	Phone : (713) 691-6565
Material: EPS 2.0#	Fax : (713) 691-6564

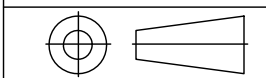

<b>Bands</b>	MM#:	REV: <b>A</b>

# Pier Caps

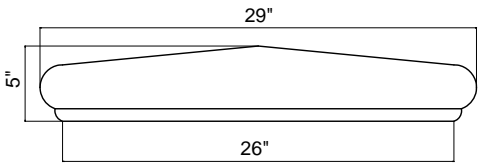

MPC#501

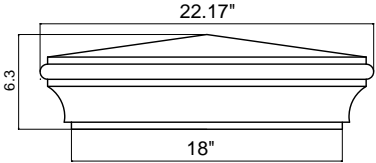

MPC#502

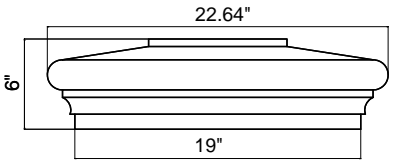

MPC#503

# Top View

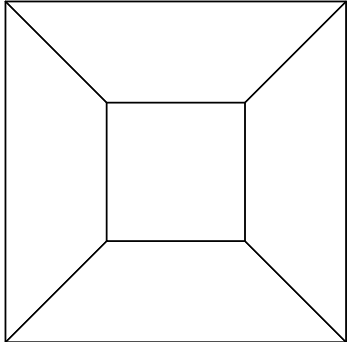
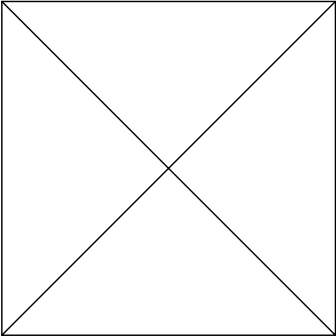
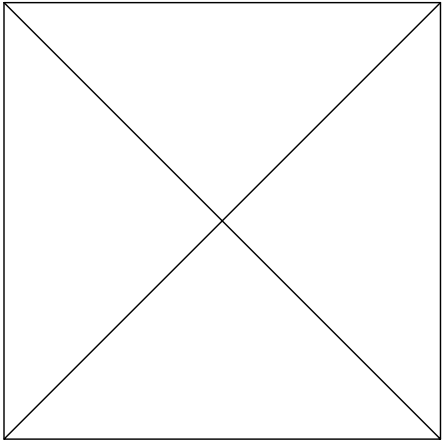

This is an original unpublished drawing created by Morrell Masonry Supply, Inc. It is submitted for your personal use in connection with a project being planned for you by Morrell Masonry Supply, Inc. It is not to be shown to anyone outside your organization, nor is it to be used, reproduced, copied, or exhibited in any fashion. ALL RIGHTS RESERVED!

Material: EPS 1.0#	501 W. Parker Rd. Houston, Texas 77091
Material: EPS 2.0#	Phone : (713) 691-6565
	Fax : (713) 691-6564

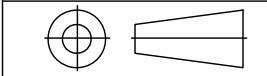

<b>Piercaps</b>	MM#:	REV: <b>A</b>
-----------------	------	---------------



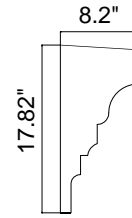

MAR#307

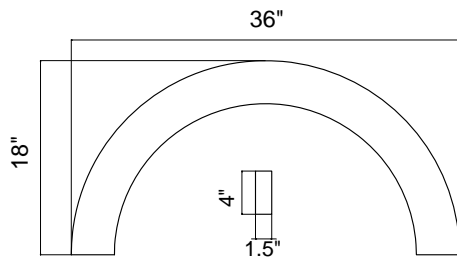
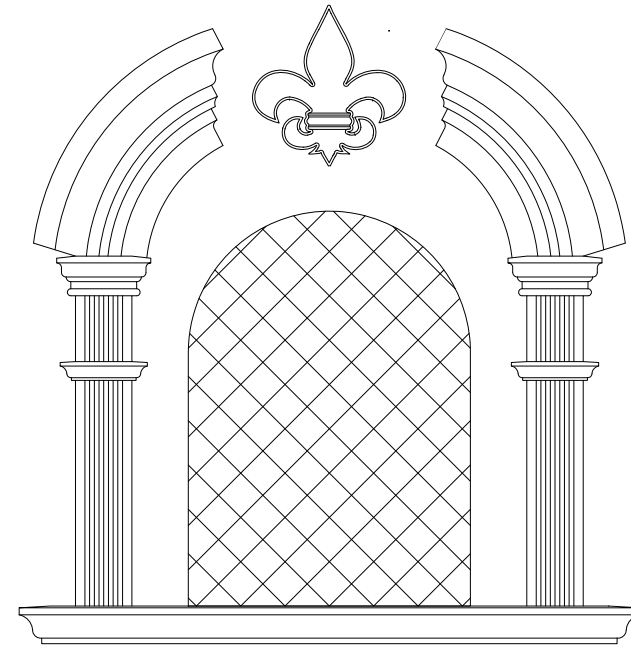

MAR#305

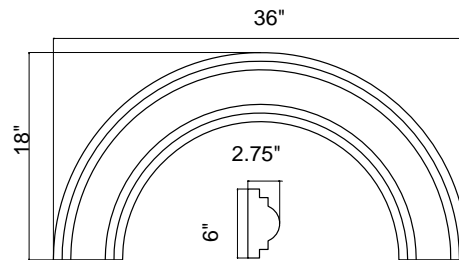

MAR#306

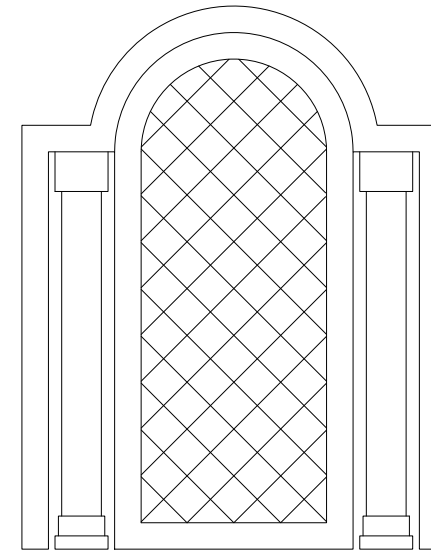

This is an original unpublished drawing created by Morrell Masonry Supply, Inc. It is submitted for your personal use in connection with a project being planned for you by Morrell Masonry Supply, Inc. It is not to be shown to anyone outside your organization, nor is it to be used, reproduced, copied, or exhibited in any fashion. ALL RIGHTS RESERVED!

Material: EPS 1.0#

Material: EPS 2.0#

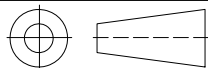

Phone : (713) 691-6565

ARCHES

501 W. Parker Rd. Houston, Texas 77091

Fax : (713) 691-6564

MM#:

REV:

A





Side View

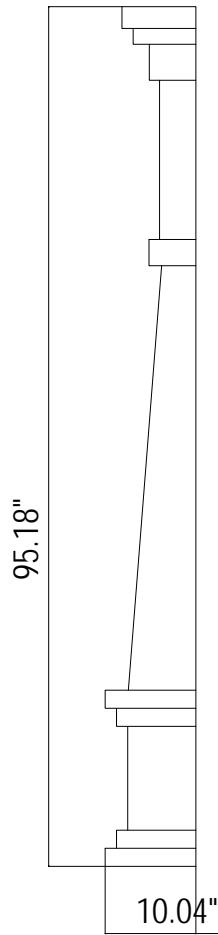

Front View

107.51"

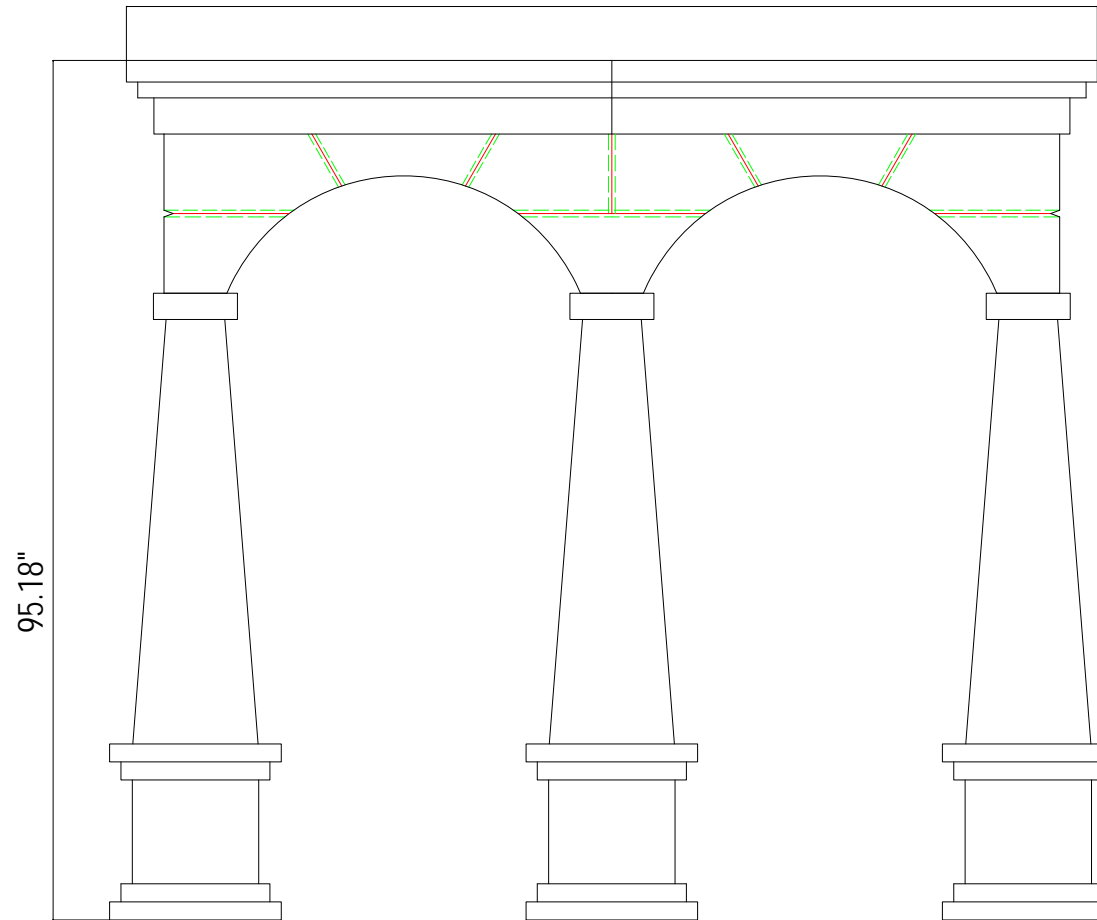

This is an original unpublished drawing created by Morrell Masonry Supply, Inc. It is submitted for your personal use in connection with a project being planned for you by Morrell Masonry Supply, Inc. It is not to be shown to anyone outside your organization, nor is it to be used, reproduced, copied, or exhibited in any fashion. ALL RIGHTS RESERVED!

Material: EPS 1.0#

Material: EPS 2.0#

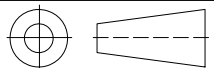

Phone : (713) 691-6565

**ARCHES**

501 W. Parker Rd. Houston, Texas 77091

Fax : (713) 691-6564

MM#:

REV:

**A**



# Cornices

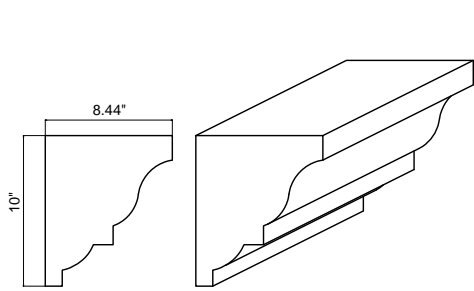

MC#703

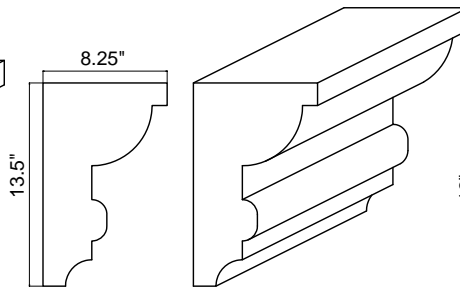

MC#704

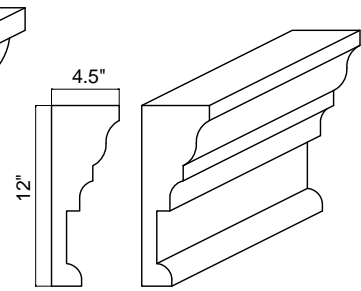

MC#705

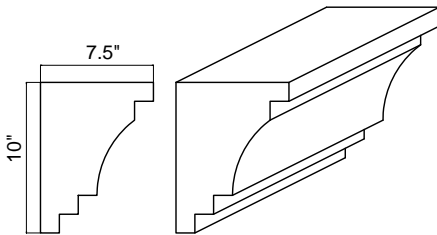

MC#706

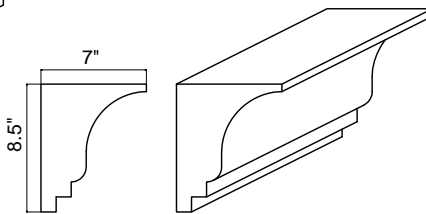

MC#707

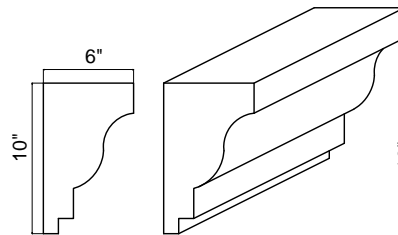

MC#708

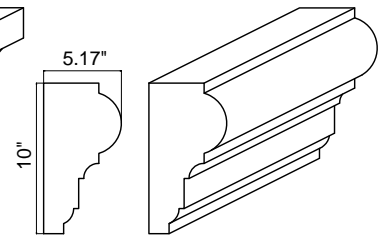

MC#709

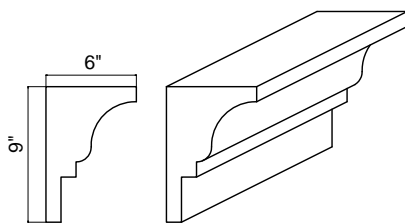

MC#710

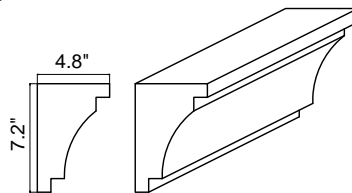

MC#711

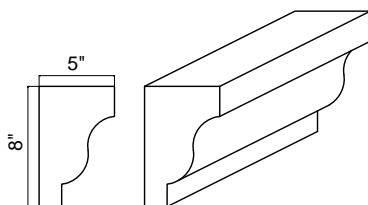

MC#712

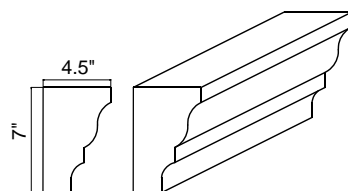

MC#713

This is an original unpublished drawing created by Morrell Masonry Supply, Inc. It is submitted for your personal use in connection with a project being planned for you by Morrell Masonry Supply, Inc. It is not to be shown to anyone outside your organization, nor is it to be used, reproduced, copied, or exhibited in any fashion. ALL RIGHTS RESERVED!

Material: EPS 1.0#  
Material: EPS 2.0#

501 W. Parker Rd. Houston, Texas 77091  
Phone : (713) 691-6565  
Fax : (713) 691-6564

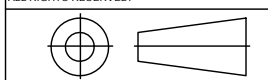

**Cornices**

MM#:

REV: **A**

# SILLS

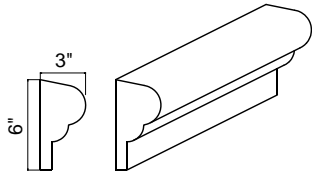

MB#802

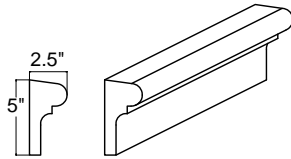

MB#803

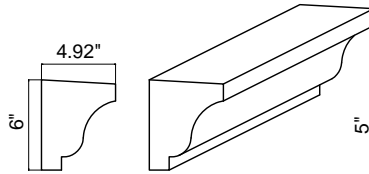

MB#804

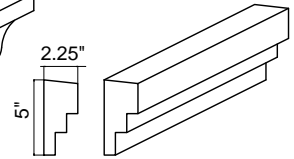

MB#805

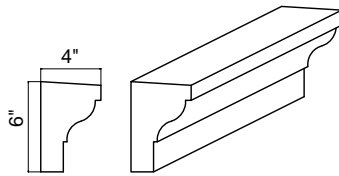

MB#806

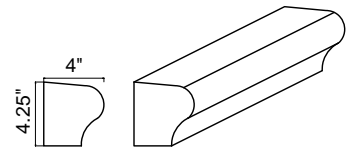

MB#807

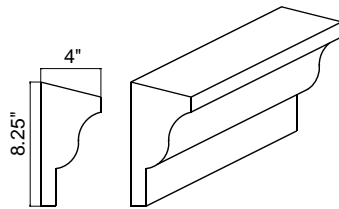

MB#808

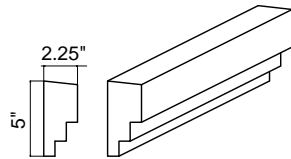

MB#809

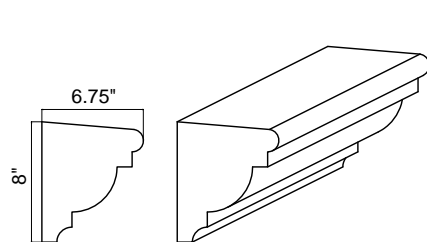

MB#810

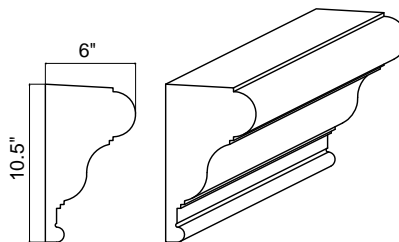

MB#811

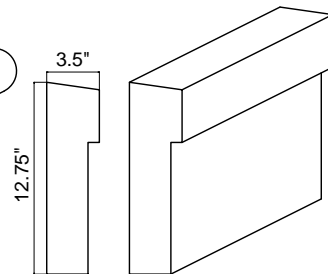

MB#812



This is an original unpublished drawing created by Morrell Masonry Supply, Inc. It is submitted for your personal use in connection with a project being planned for you by Morrell Masonry Supply, Inc. It is not to be shown to anyone outside your organization, nor is it to be used, reproduced, copied, or exhibited in any fashion. ALL RIGHTS RESERVED!

Material: EPS 1.0#	501 W. Parker Rd. Houston, Texas 77091
Material: EPS 2.0#	Phone : (713) 691-6565
	Fax : (713) 691-6564

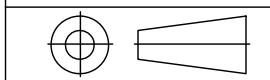

<b>Sills</b>	MM#:	REV: <b>A</b>
--------------	------	---------------



## Columns

Columns can be made to any length and design choosing from any style of cap, base and shaft.  
 Columns can made solid or with a specified cut out to attach to existing center support.  
 Columns specifications include overall height, diameter of shaft and style of base, cap and shaft.

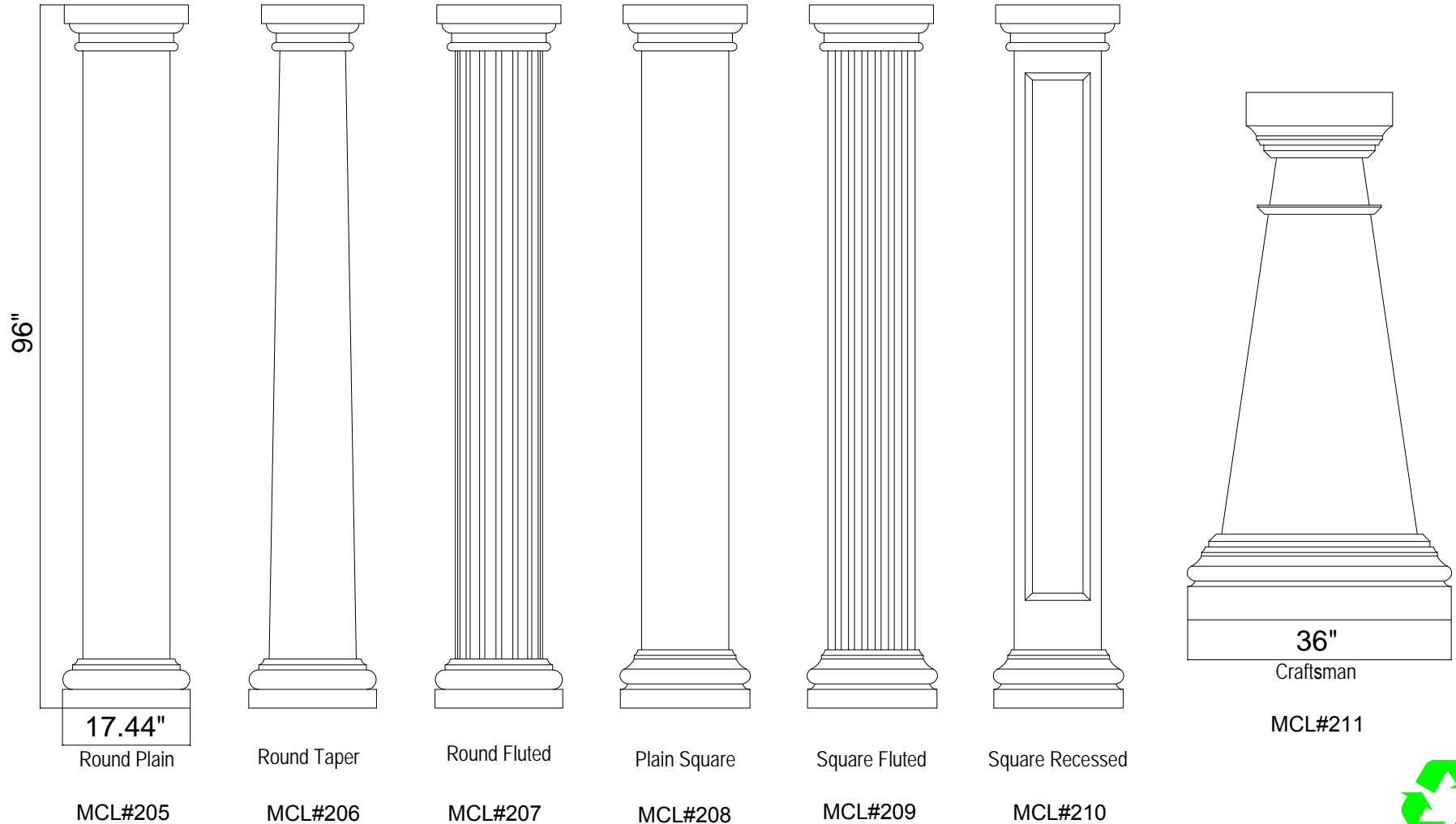

This is an original unpublished drawing created by Morrell Masonry Supply, Inc. It is submitted for your personal use in connection with a project being planned for you by Morrell Masonry Supply, Inc. It is not to be shown to anyone outside your organization, nor is it to be used, reproduced, copied, or exhibited in any fashion. ALL RIGHTS RESERVED!

Material: EPS 1.0#

Material: EPS 2.0#

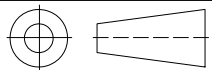

Phone : (713) 691-6565

### COLUMNS

501 W. Parker Rd. Houston, Texas 77091

Fax : (713) 691-6564

MM#:

REV:

A



# Columns Capitals

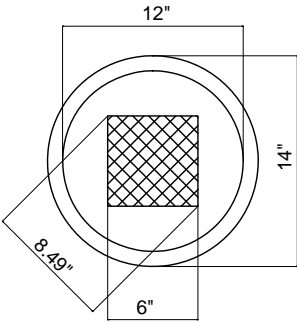
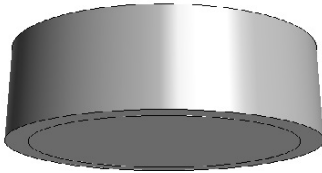
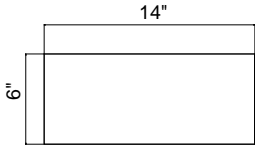

MCS#250

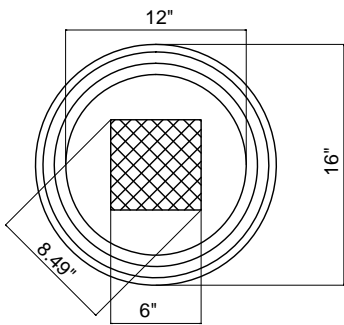
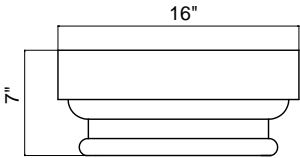

MCS#251

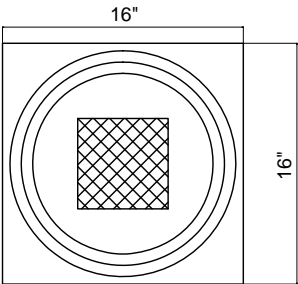
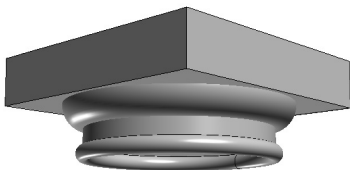
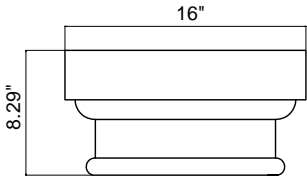

MCS#252

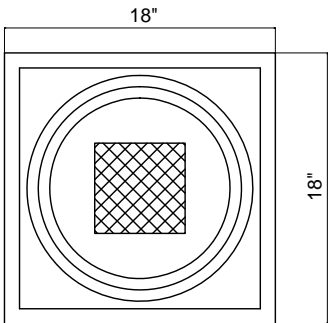
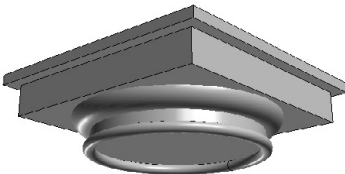
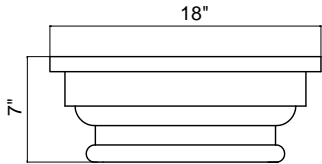

MCS#253



This is an original unpublished drawing created by Morrell Masonry Supply, Inc. It is submitted for your personal use in connection with a project being planned for you by Morrell Masonry Supply, Inc. It is not to be shown to anyone outside your organization, nor is it to be used, reproduced, copied, or exhibited in any fashion. ALL RIGHTS RESERVED!

501 W. Parker Rd. Houston, Texas 77091	
Material: EPS 1.0#	Phone : (713) 691-6565
Material: EPS 2.0#	Fax : (713) 691-6564

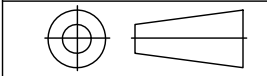

<b>Columns Capitals</b>	MM#:	REV: <b>A</b>
-------------------------	------	---------------

# Columns Capitals

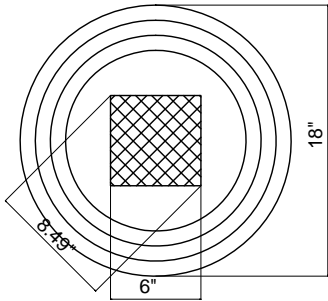
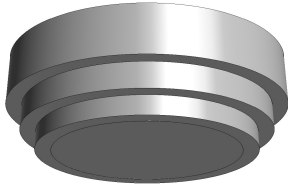
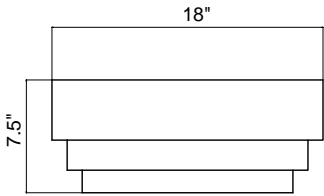

MCS#254

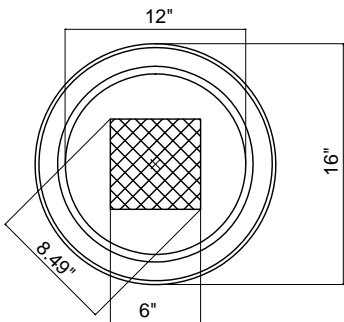
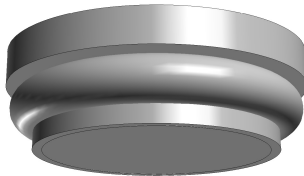
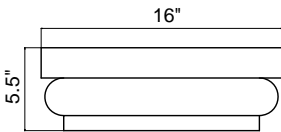

MCS#255

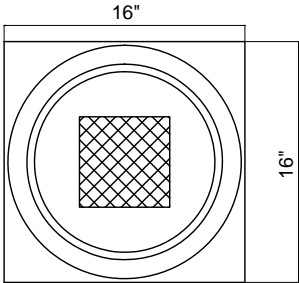
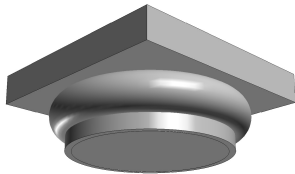
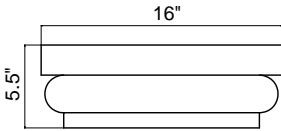

MCS#256

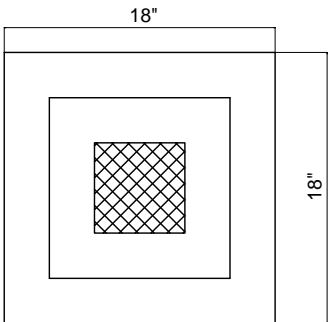
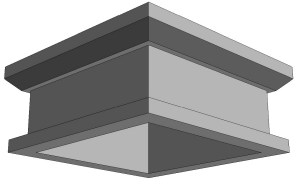
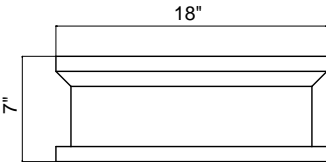

MCS#257



This is an original unpublished drawing created by Morrell Masonry Supply, Inc. It is submitted for your personal use in connection with a project being planned for you by Morrell Masonry Supply, Inc. It is not to be shown to anyone outside your organization, nor is it to be used, reproduced, copied, or exhibited in any fashion. ALL RIGHTS RESERVED!

Material: EPS 1.0#	501 W. Parker Rd. Houston, Texas 77091
Material: EPS 2.0#	Phone : (713) 691-6565
	Fax : (713) 691-6564

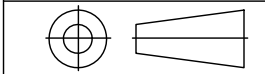

<b>Columns Capitals</b>	MM#:	REV: <b>A</b>
-------------------------	------	---------------

# Columns Bases

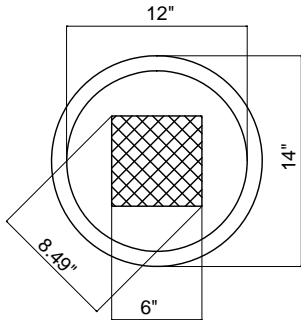
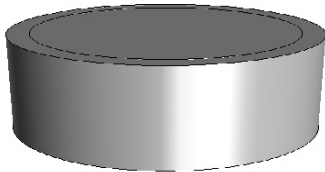
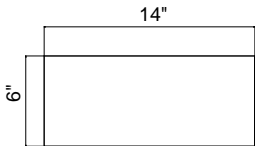

MBS#280

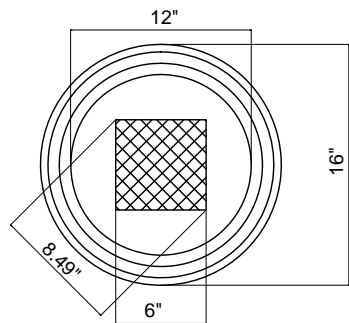
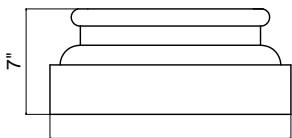

MBS#281

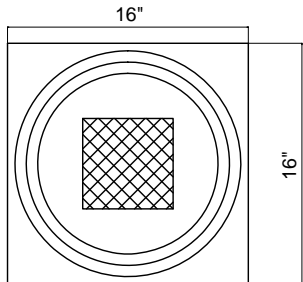
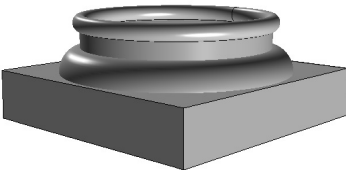
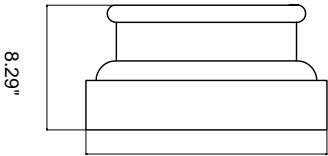

MBS#282

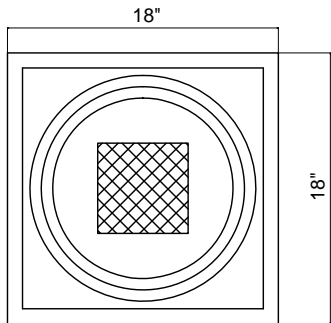
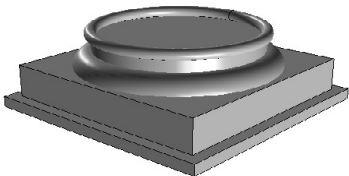
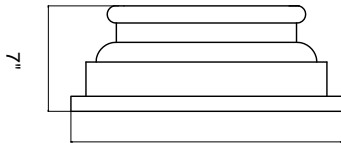

MBS#283



This is an original unpublished drawing created by Morrell Masonry Supply, Inc. It is submitted for your personal use in connection with a project being planned for you by Morrell Masonry Supply, Inc. It is not to be shown to anyone outside your organization, nor is it to be used, reproduced, copied, or exhibited in any fashion. ALL RIGHTS RESERVED!

Material: EPS 1.0#	501 W. Parker Rd. Houston, Texas 77091
Material: EPS 2.0#	Phone : (713) 691-6565
	Fax : (713) 691-6564

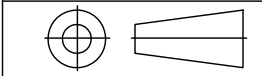

<b>Columns Bases</b>	MM#:	REV: <b>A</b>
----------------------	------	---------------

# Columns Bases

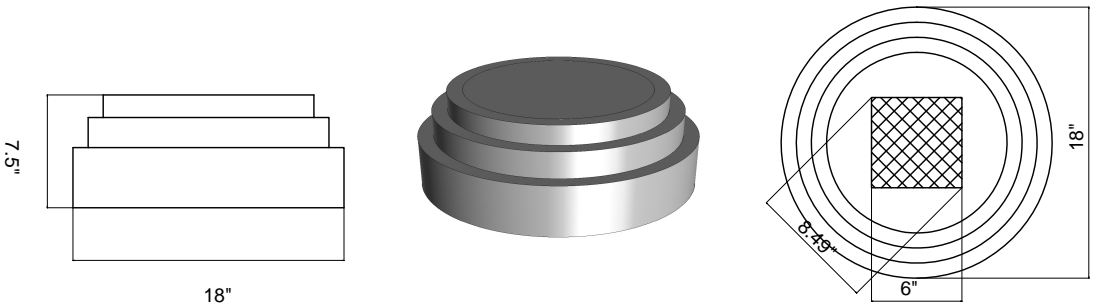

**MBS#284**

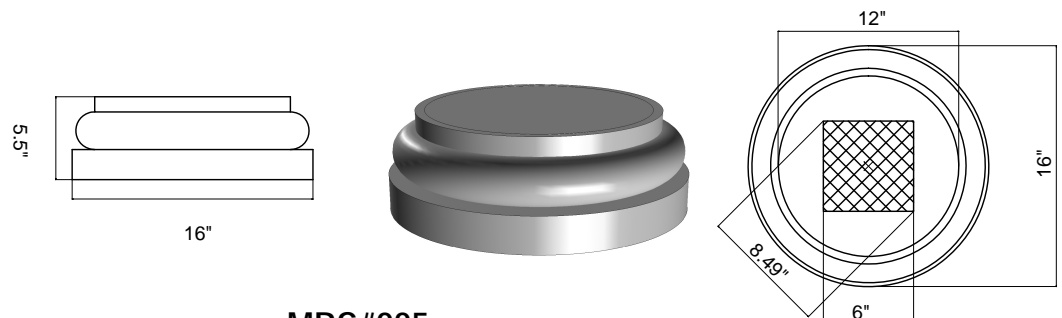

**MBS#285**

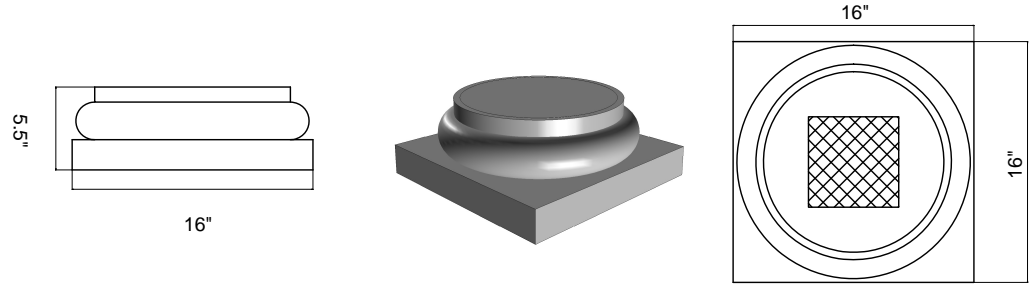

**MBS#286**



**MBS#287**



This is an original unpublished drawing created by Morrell Masonry Supply, Inc. It is submitted for your personal use in connection with a project being planned for you by Morrell Masonry Supply, Inc. It is not to be shown to anyone outside your organization, nor is it to be used, reproduced, copied, or exhibited in any fashion. ALL RIGHTS RESERVED!

Material: EPS 1.0#	501 W. Parker Rd. Houston, Texas 77091
Material: EPS 2.0#	Phone : (713) 691-6565
	Fax : (713) 691-6564

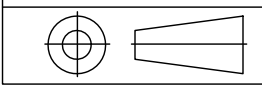

<b>Columns Bases</b>	MM#:	REV: <b>A</b>
----------------------	------	---------------

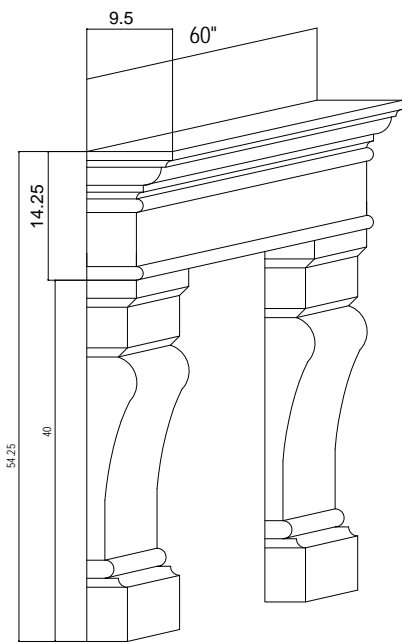

SOFIA

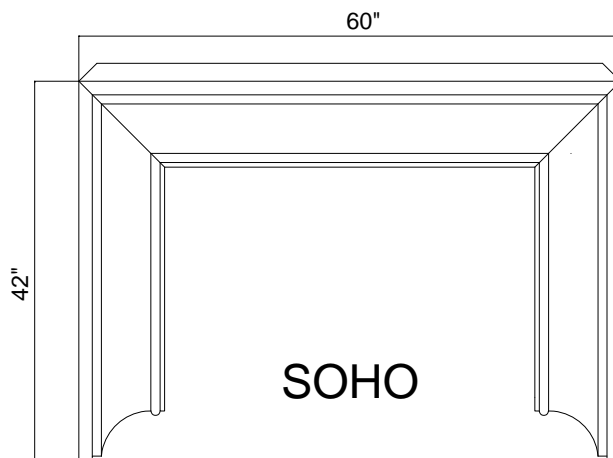
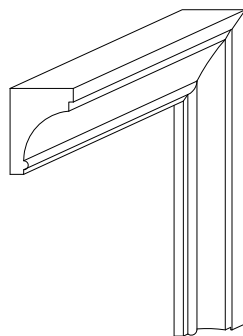
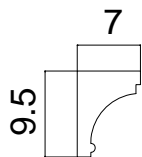
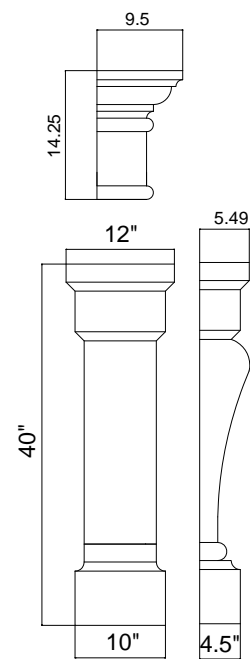

SOHO



This is an original unpublished drawing created by Morrell Masonry Supply, Inc. It is submitted for your personal use in connection with a project being planned for you by Morrell Masonry Supply, Inc. It is not to be shown to anyone outside your organization, nor is it to be used, reproduced, copied, or exhibited in any fashion. ALL RIGHTS RESERVED!

Material: EPS 1.0#

Material: EPS 2.0#

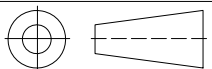

Phone : (713) 691-6565

FIREPLACE

501 W. Parker Rd. Houston, Texas 77091

Fax : (713) 691-6564

MM#:

REV:  
A





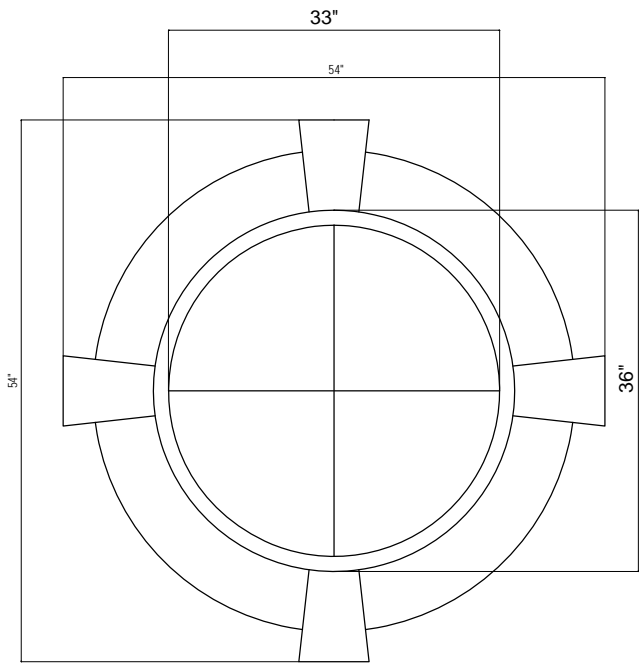

**MQ#860**

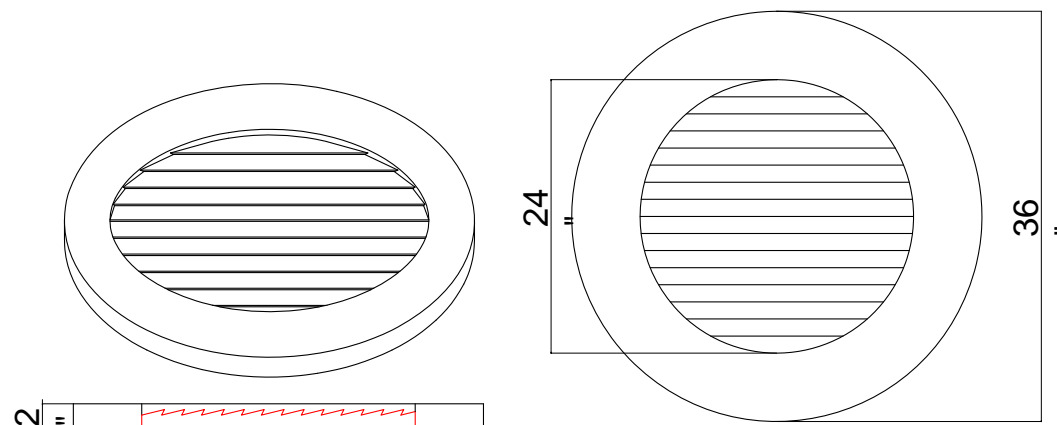
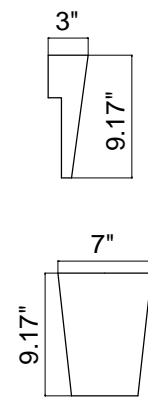
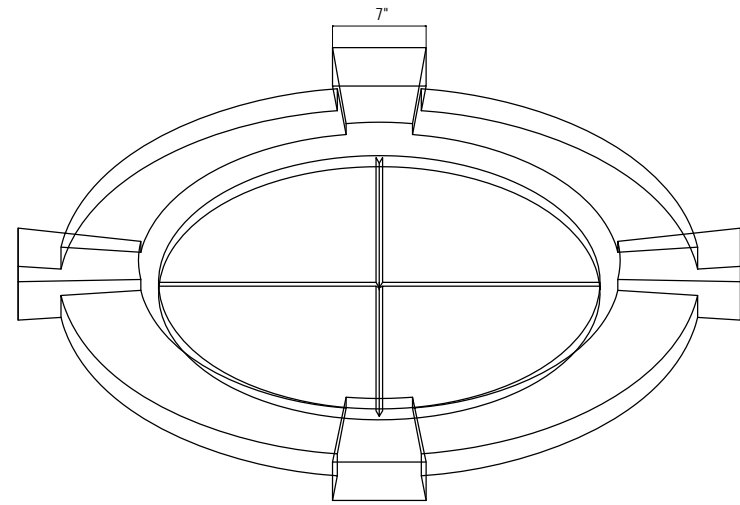

**MQ#861**

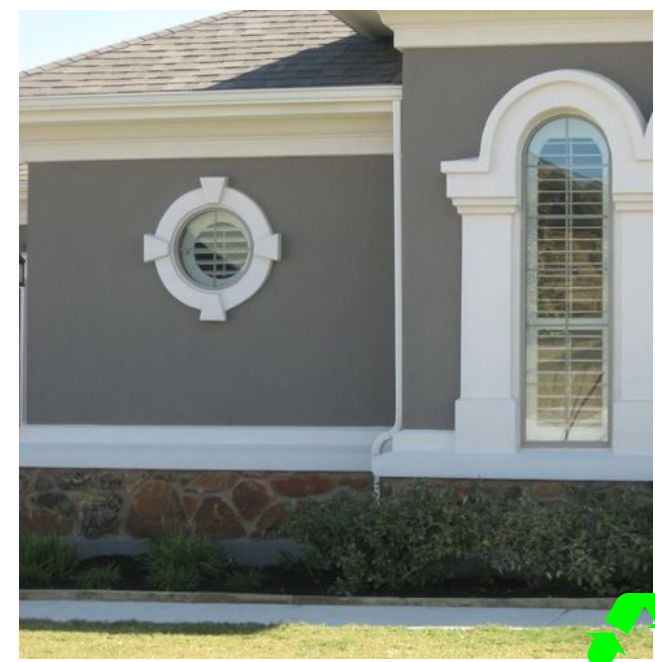

This is an original unpublished drawing created by Morrell Masonry Supply, Inc. It is submitted for your personal use in connection with a project being planned for you by Morrell Masonry Supply, Inc. It is not to be shown to anyone outside your organization, nor is it to be used, reproduced, copied, or exhibited in any fashion. ALL RIGHTS RESERVED!

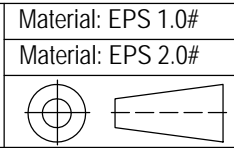

501 W. Parker Rd. Houston, Texas 77091  
Phone : (713) 691-6565

Fax : (713) 691-6564  
MM#:

REV:  
**A**



**QUATREFOIL**

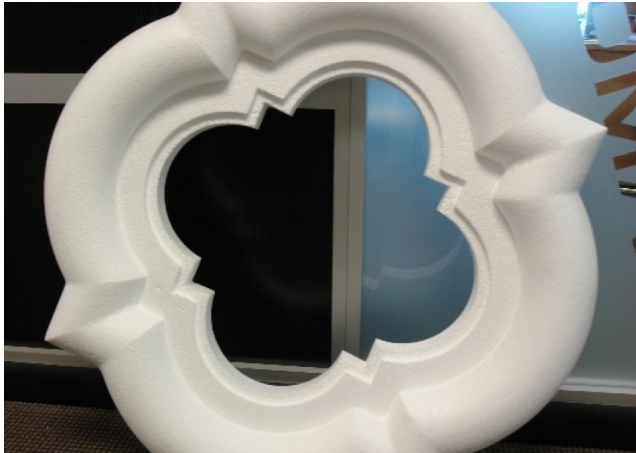
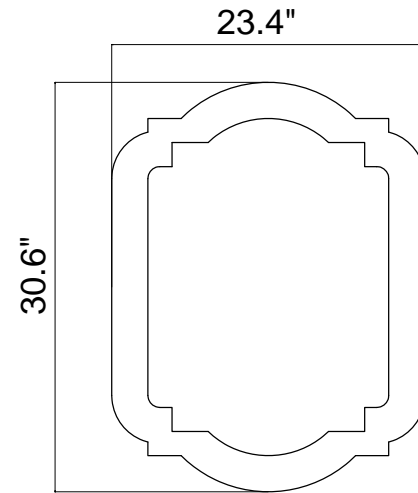
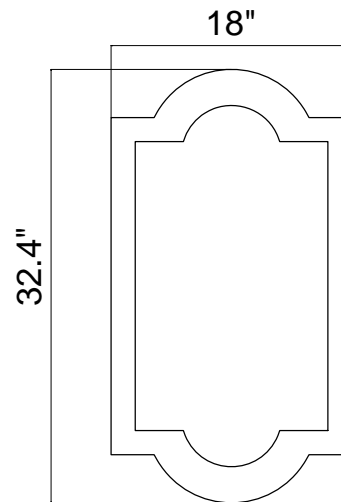
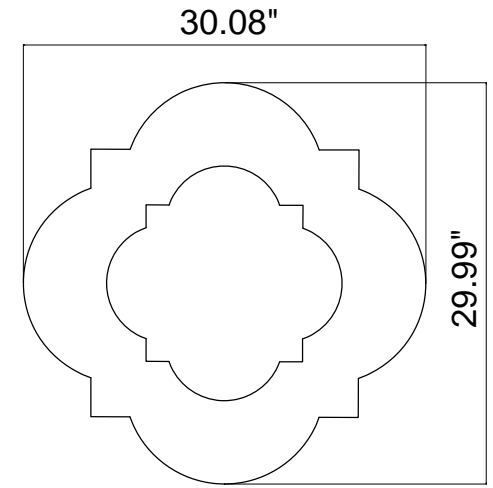
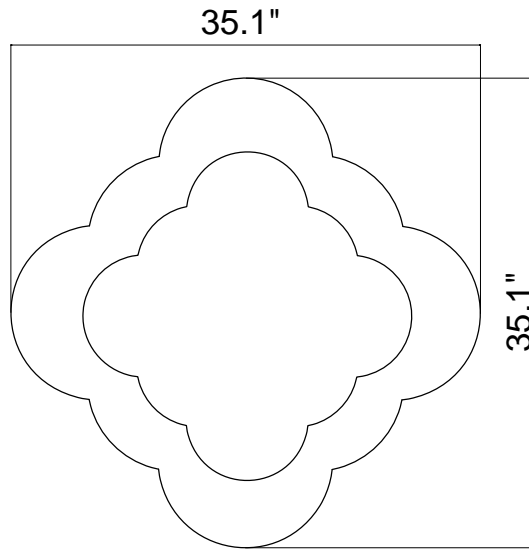
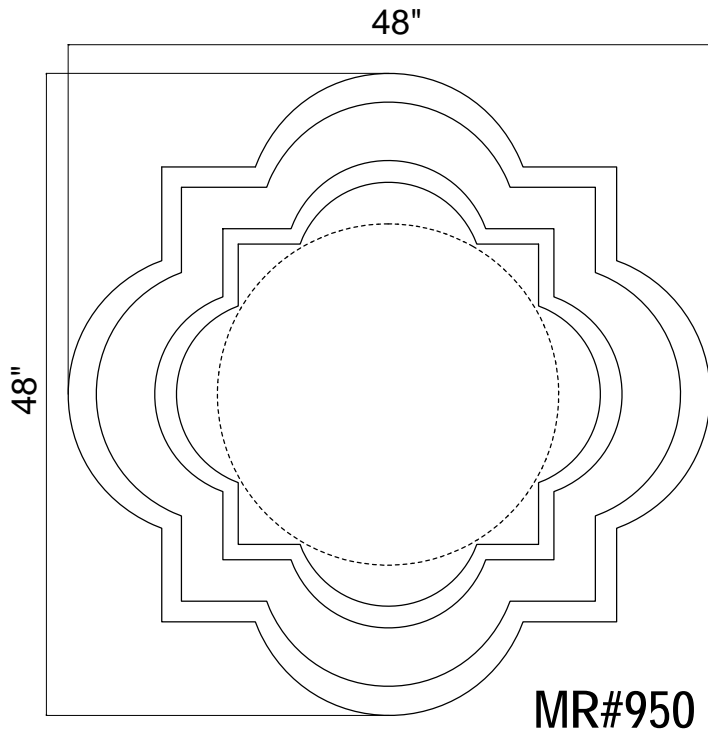

This is an original unpublished drawing created by Morrell Masonry Supply, Inc. It is submitted for your personal use in connection with a project being planned for you by Morrell Masonry Supply, Inc. It is not to be shown to anyone outside your organization, nor is it to be used, reproduced, copied, or exhibited in any fashion. ALL RIGHTS RESERVED!

Material: EPS 1.0#

Material: EPS 2.0#

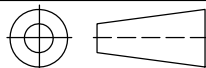

Phone : (713) 691-6565

ROSSETTES

501 W. Parker Rd. Houston, Texas 77091

Fax : (713) 691-6564

MM#:

REV:

A



# Keystones

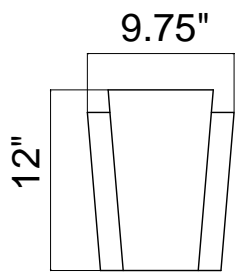

MK#350

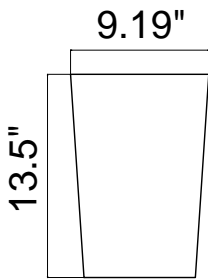
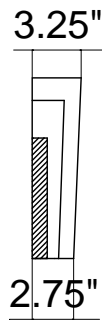

MK#351

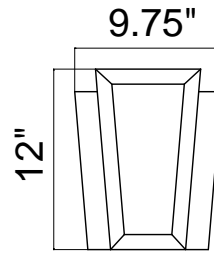
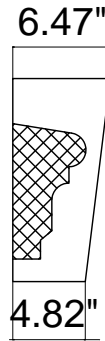

MK#352

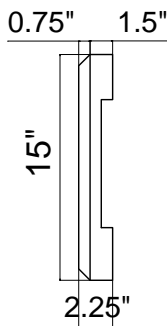
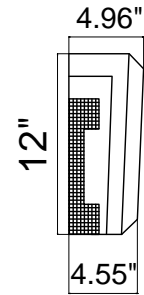

MK#353

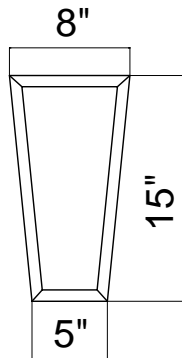
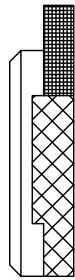

MK#354

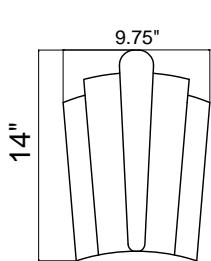
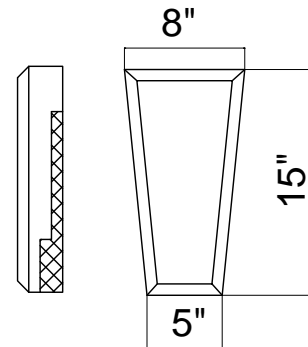
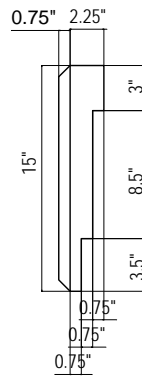

MK#355

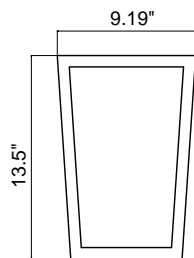
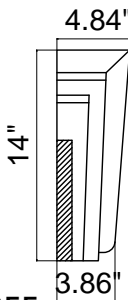

MK#356

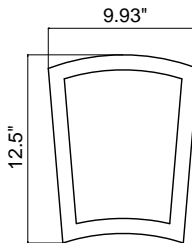

MK#357

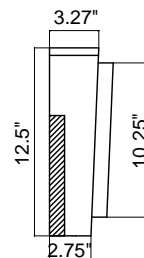

This is an original unpublished drawing created by Morrell Masonry Supply, Inc. It is submitted for your personal use in connection with a project being planned for you by Morrell Masonry Supply, Inc. It is not to be shown to anyone outside your organization, nor is it to be used, reproduced, copied, or exhibited in any fashion. ALL RIGHTS RESERVED!

Material: EPS 1.0#	501 W. Parker Rd. Houston, Texas 77091
Material: EPS 2.0#	Phone : (713) 691-6565
	Fax : (713) 691-6564

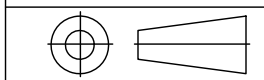

<b>Keystones</b>	MM#:	REV: <b>A</b>
------------------	------	---------------

# Corbels

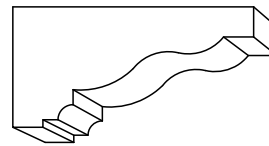
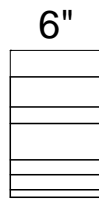
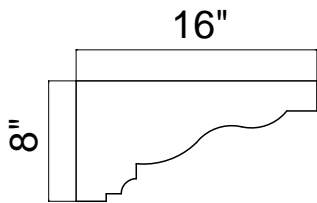

MCB#880

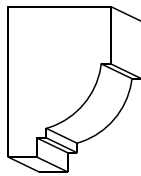
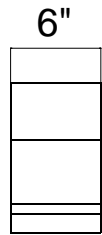
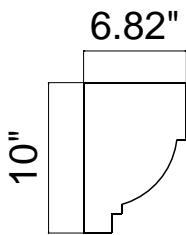

MCB#881

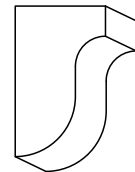
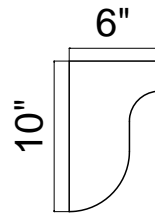

MCB#882

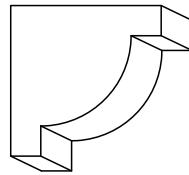
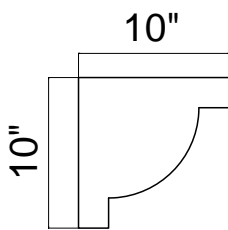

MCB#883

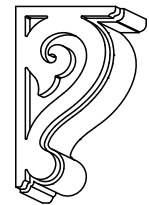
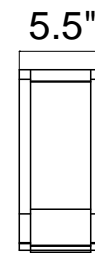
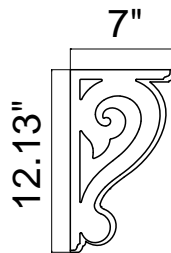

MCB#884



This is an original unpublished drawing created by Morrell Masonry Supply, Inc. It is submitted for your personal use in connection with a project being planned for you by Morrell Masonry Supply, Inc. It is not to be shown to anyone outside your organization, nor is it to be used, reproduced, copied, or exhibited in any fashion. ALL RIGHTS RESERVED!

Material: EPS 1.0#  
Material: EPS 2.0#

501 W. Parker Rd. Houston, Texas 77091  
Phone : (713) 691-6565  
Fax : (713) 691-6564

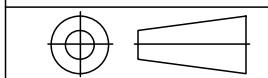

**Corbels**

MM#:

REV: **A**

# Dentil Moldings

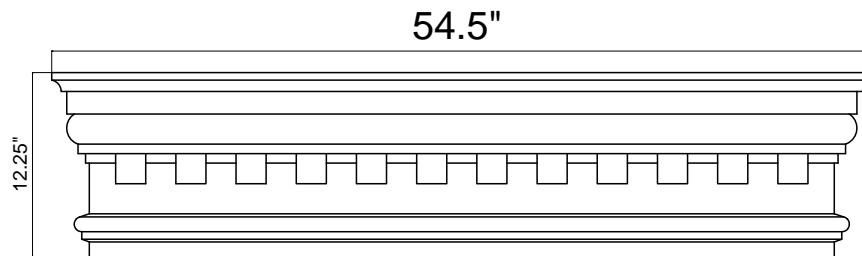
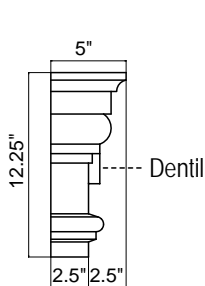
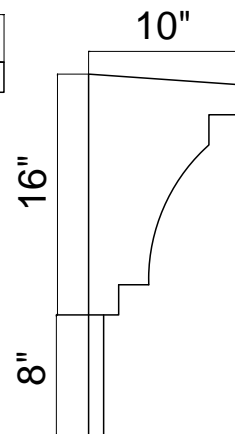
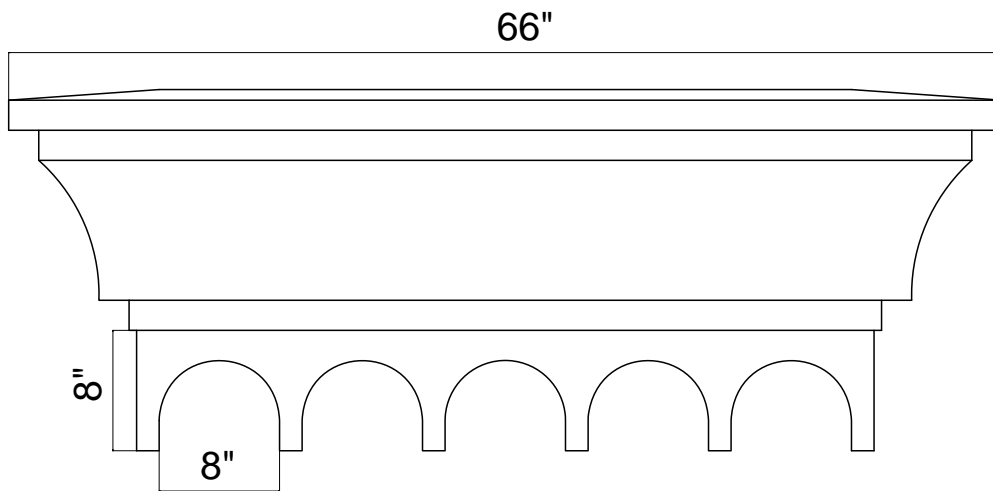
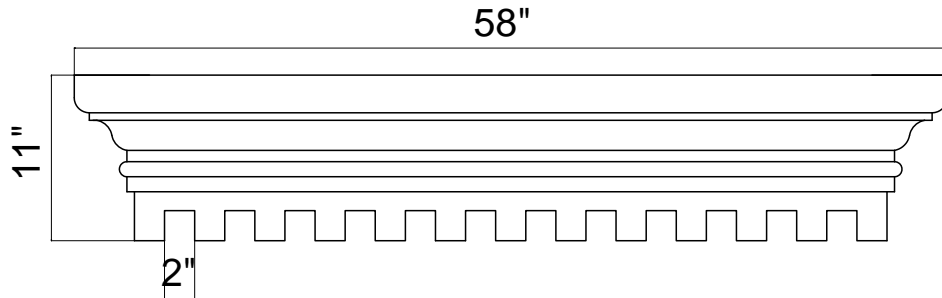
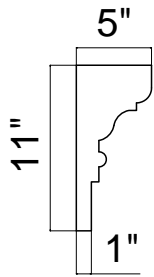

This is an original unpublished drawing created by Morrell Masonry Supply, Inc. It is submitted for your personal use in connection with a project being planned for you by Morrell Masonry Supply, Inc. It is not to be shown to anyone outside your organization, nor is it to be used, reproduced, copied, or exhibited in any fashion. ALL RIGHTS RESERVED!

	501 W. Parker Rd. Houston, Texas 77091
Material: EPS 1.0#	Phone : (713) 691-6565
Material: EPS 2.0#	Fax : (713) 691-6564

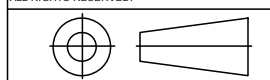

<b>Dentil Moldings</b>	MM#:	REV: <b>A</b>
------------------------	------	---------------